



APPLICATION

The Pressure-Tru™ Z3004 Series Pressure Reducing Valve is listed as a floor control valve, an indicating valve, and a check valve in automatic sprinkler systems as well as a standpipe valve for CLASS I and CLASS III systems. Regulates pressure under both flow and no-flow conditions. Can be adjusted and set at the factory or set in the field without draining the standpipe riser and fire sprinkler system.

STANDARDS COMPLIANCE

- UL® Listed
- C-UL® Listed
- City of Los Angeles Approved
- NYC MEA 37-95-E

MATERIAL

Main valve body Cast bronze ASTM B 584
 Stem Silicon bronze ASTM B 584
 Flange Navy "G" bronze ASTM B 584
 Elastomers Buna Nitrile (FDA approved)
 EPDM (FDA approved)
 Springs Chrome silicon, ASTM A 313 powder coated

OPTIONS

(Suffixes can be combined)

- angle type valve
- IL - in-line (globe type) valve
- MSA - with monitor switch adapter
- CH - with chrome finish
- SS - with integral supervisory switch; contact rating of 3 amps at 125VAC and a tamper-resistant cover
- T - tapped & plugged inlet and outlet for pressure gauge (Not available on angle grooved body)
- CAP - with capped bonnet, no handwheel assembly
- G - Grooved inlet / outlet connections

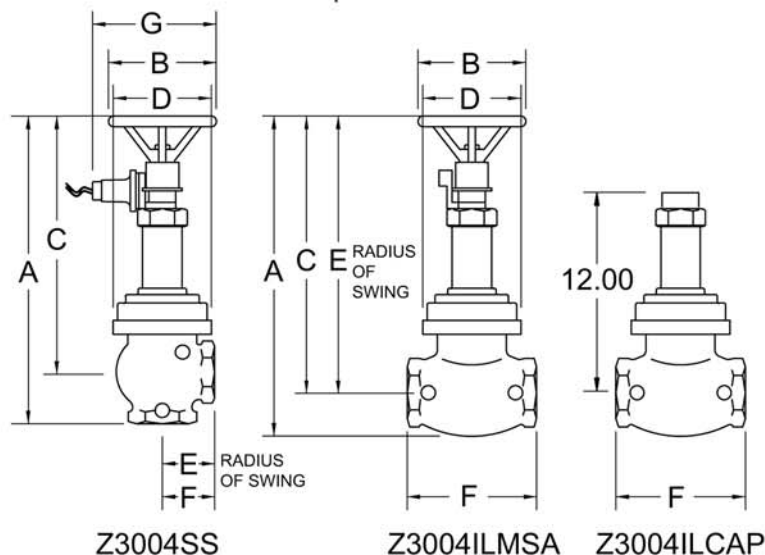

FEATURES

Sizes: 1 1/2"
 Maximum inlet pressure 400 psi
 Inlet connection FNPT
 Outlet connection (Z2100) Male hose
 Outlet connection (Z2105) FNPT
 Manufactured in the USA
 Factory or Field Set

DIMENSIONS & WEIGHTS (do not include pkg.)

MODEL	DIMENSIONS (approximate)																			
	A OPEN		A CLOSED		B		C OPEN		C CLOSED		D		E		F		G		WEIGHT	
	in.	mm	in.	mm	in.	mm	in.	mm	in.	mm	in.	mm	in.	mm	in.	mm	in.	mm	lbs	kg
Z3004	19 1/2	495	18 1/2	470	6 1/4	159	16 1/2	419	15 1/2	394	5 3/4	146	3 1/2	89	3	76	N/A	N/A	30	13.6
Z3004IL	19 1/2	495	18 1/2	470	6 1/4	159	16 1/2	419	15 1/2	394	5 3/4	146	21	533	7 1/2	191	N/A	N/A	34	15.4
Z3004SS	19 1/2	495	18 1/2	470	6 1/4	159	16 1/2	419	15 1/2	394	5 3/4	146	3 1/2	89	3	76	7 1/2	191	30	13.6
Z3004G	19 1/2	495	18 1/2	470	6 1/4	159	16 1/2	419	15 1/2	394	5 3/4	146	3 1/2	89	3	76	N/A	N/A	30	13.6
Z3004ILG	19 1/2	495	18 1/2	470	6 1/4	159	16 1/2	419	15 1/2	394	5 3/4	146	21	533	8 3/4	222	N/A	N/A	34	15.2

Residual Pressure Charts

For Pressure-Tru™ 2 1/2" Angle Valves

Models: Z3000, Z3004, Z3005, Z3000G & Z3004G

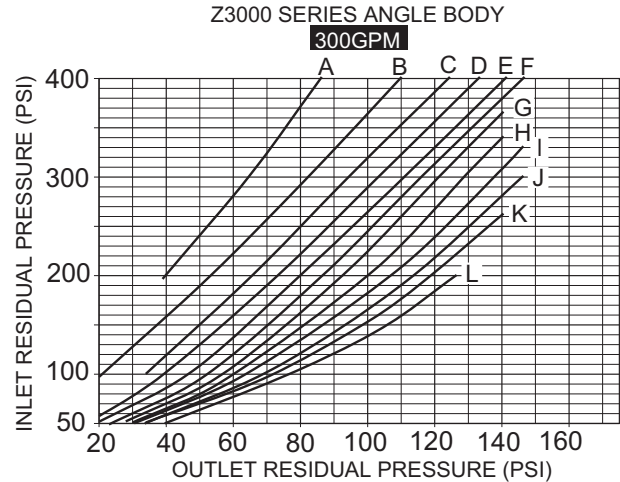
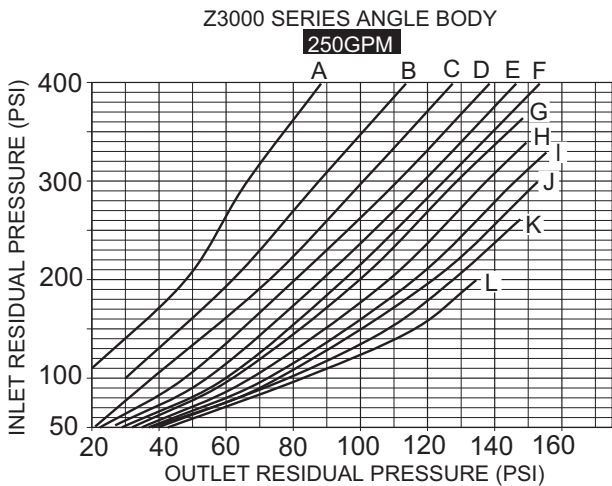
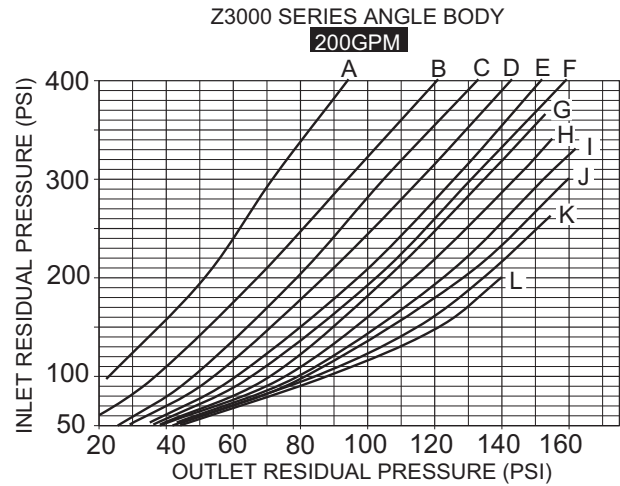
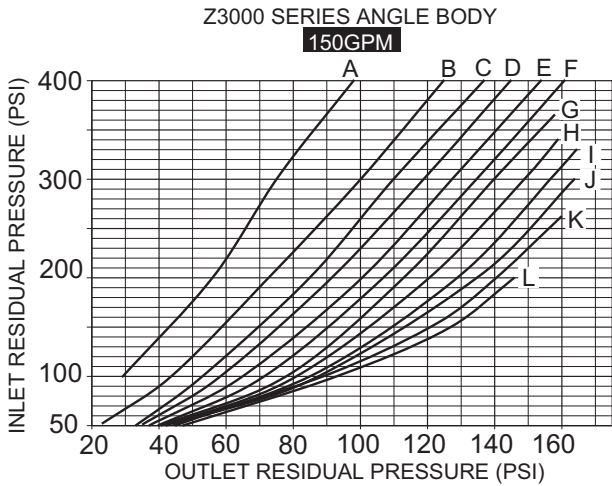
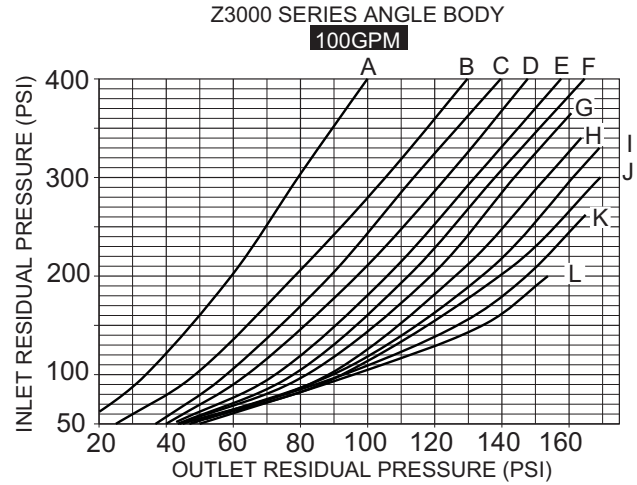
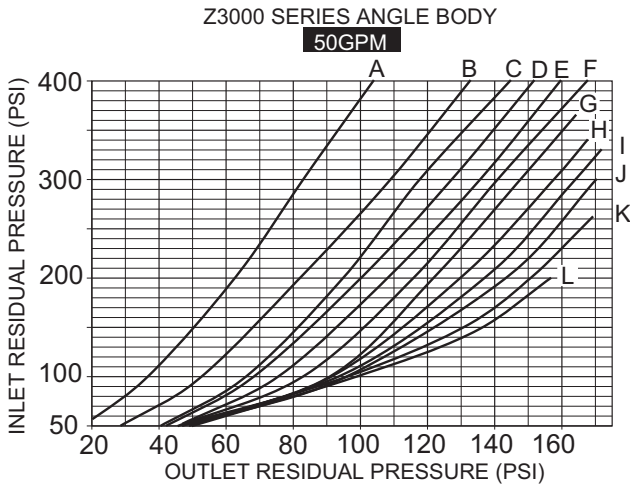

"A" DIMENSION SETTINGS (inches)

A	B	C	D	E	F	G	H	I	J	K	L
3/8	1/2	5/8	11/16	3/4	13/16	7/8	15/16	1	1-1/16	1-1/8	1-3/16

Note: Curve accuracy = ± 5 PSIG

WILKINS a Zurn company, 1747 Commerce Way, Paso Robles, CA 93446 Phone: 805-238-7100 Fax: 805-238-5766

IN CANADA: ZURN INDUSTRIES LIMITED, 3544 Nashua Dr., Mississauga, Ontario L4V 1L2 Phone: 905-405-8272 Fax: 905-405-1292

Product Support Help Line: 877-BACKFLOW (877-222-5356) • Website: <http://www.zurn.com>

Residual Pressure Charts

For Pressure-Tru™ 2 1/2" Angle Valves

Models: Z3000, Z3004, Z3005, Z3000G & Z3004G

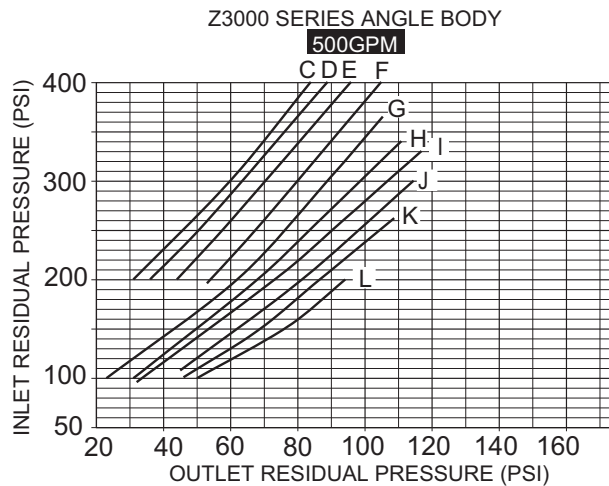
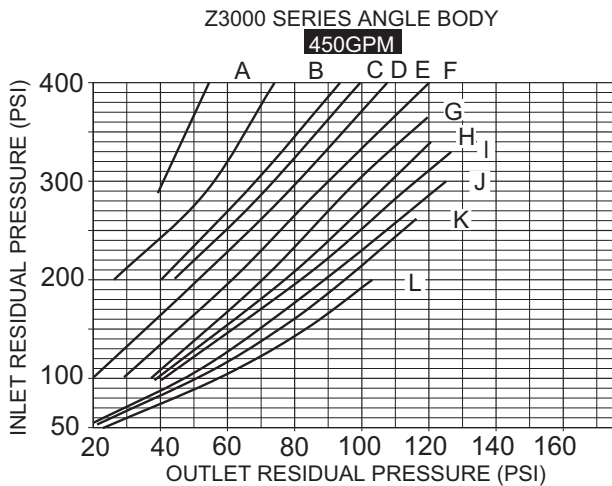
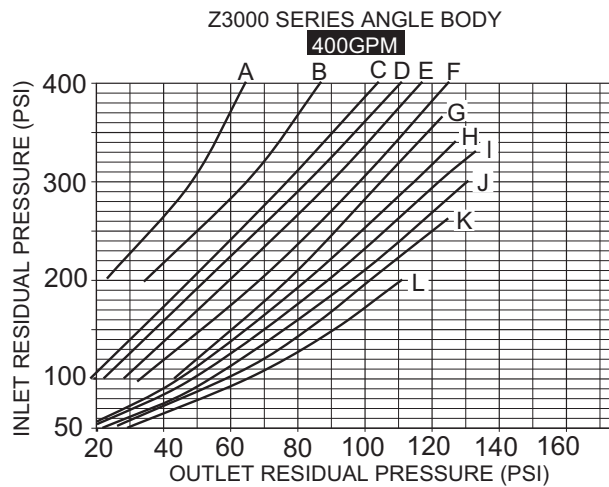
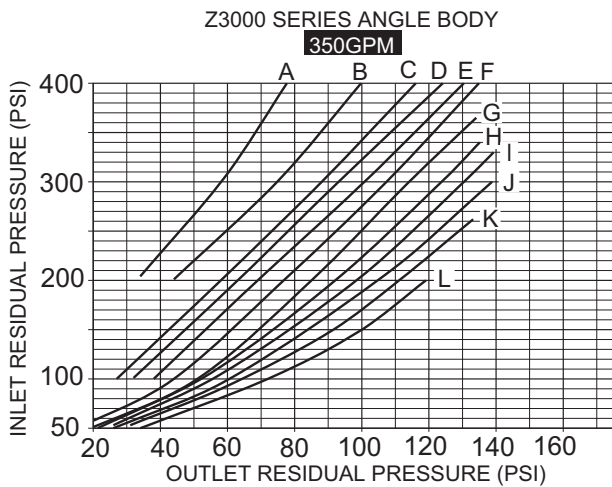

STATIC PRESSURE CHART

For Pressure-Tru™
Angle and In-line Valves
(2-1/2" Inlet and Outlet)

MODELS:
Z3000, Z3004 & Z3005
(All)

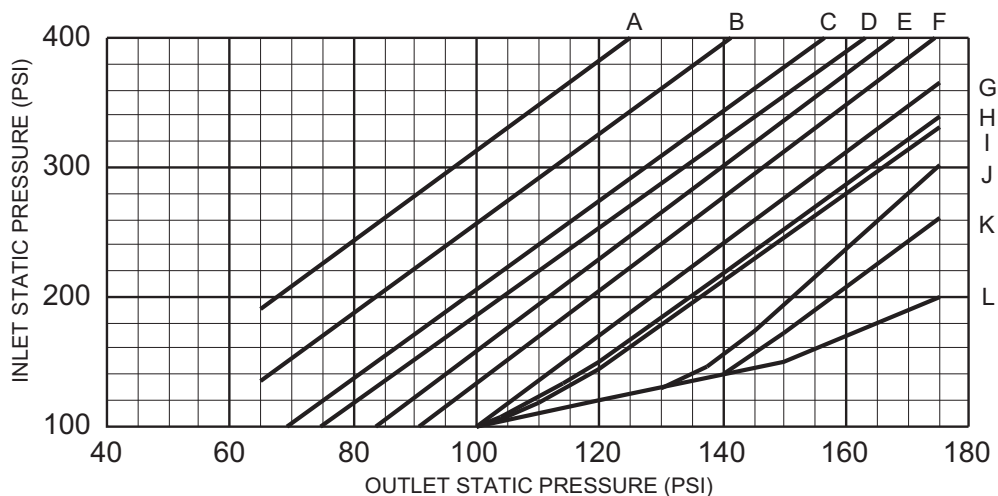

"A" DIMENSION SETTINGS (inches)											
A	B	C	D	E	F	G	H	I	J	K	L
3/8	1/2	5/8	11/16	3/4	13/16	7/8	15/16	1	1-1/16	1-1/8	1-3/16

Note: Curve accuracy = ± 5 PSIG

WILKINS a Zurn company, 1747 Commerce Way, Paso Robles, CA 93446 Phone: 805-238-7100 Fax: 805-238-5766

IN CANADA: ZURN INDUSTRIES LIMITED, 3544 Nashua Dr., Mississauga, Ontario L4V 1L2 Phone: 905-405-8272 Fax: 905-405-1292

Product Support Help Line: 877-BACKFLOW (877-222-5356) • Website: <http://www.zurn.com>

Residual Pressure Charts

For Pressure-Tru™ 2 1/2" In-line Valves

Models: Z3000IL, Z3004IL & Z3005IL

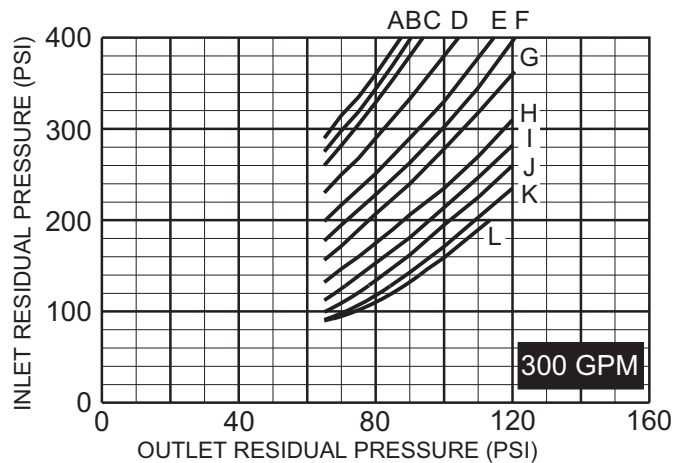
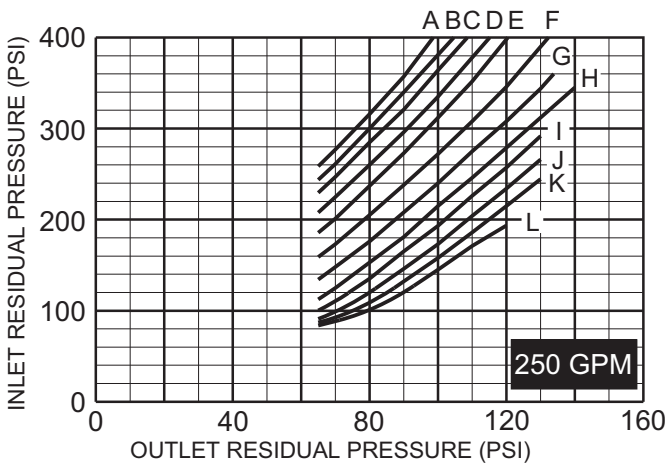
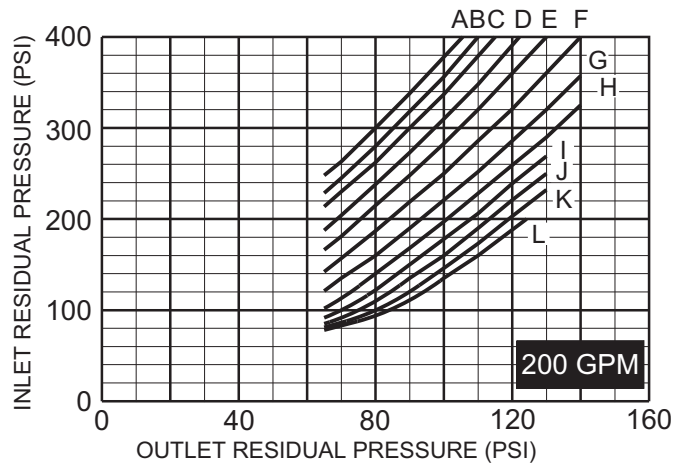
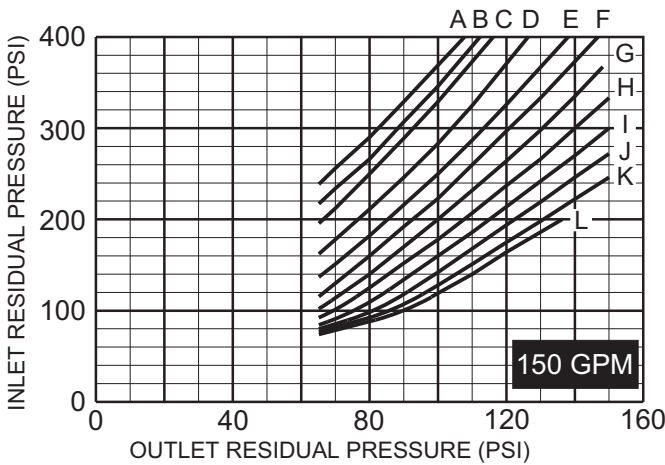
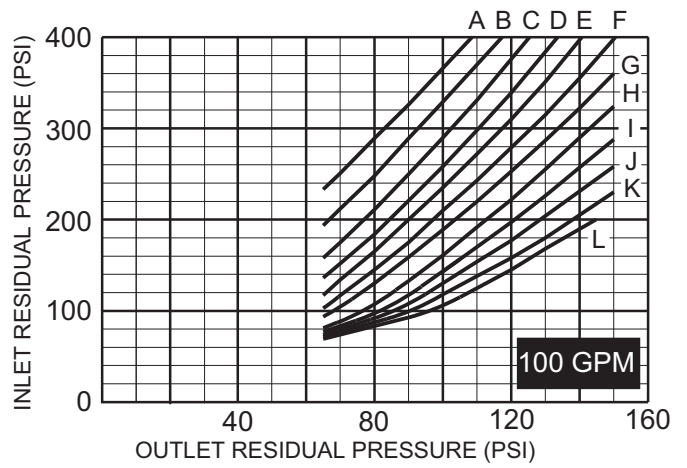
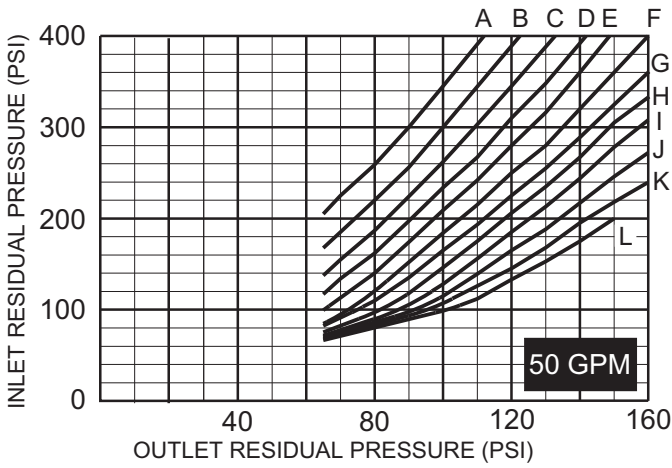

"A" DIMENSION SETTINGS (inches)											
A	B	C	D	E	F	G	H	I	J	K	L
3/8	1/2	5/8	11/16	3/4	13/16	7/8	15/16	1	1-1/16	1-1/8	1-3/16

Note: Curve accuracy= ± 5 PSIG

WILKINS a Zurn company, 1747 Commerce Way, Paso Robles, CA 93446 Phone: 805-238-7100 Fax: 805-238-5766

IN CANADA: ZURN INDUSTRIES LIMITED, 3544 Nashua Dr., Mississauga, Ontario L4V 1L2 Phone: 905-405-8272 Fax: 905-405-1292

Product Support Help Line: 877-BACKFLOW (877-222-5356) • Website: <http://www.zurn.com>

Residual Pressure Charts

For Pressure-Tru™ 2 1/2" In-line Valves

Models: Z3000IL, Z3004IL & Z3005IL

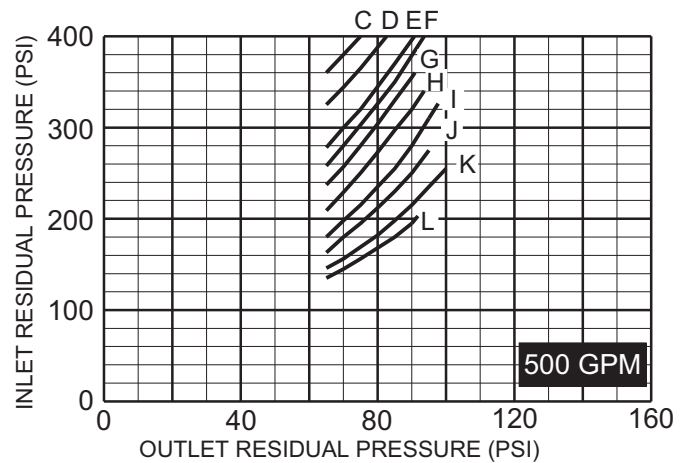
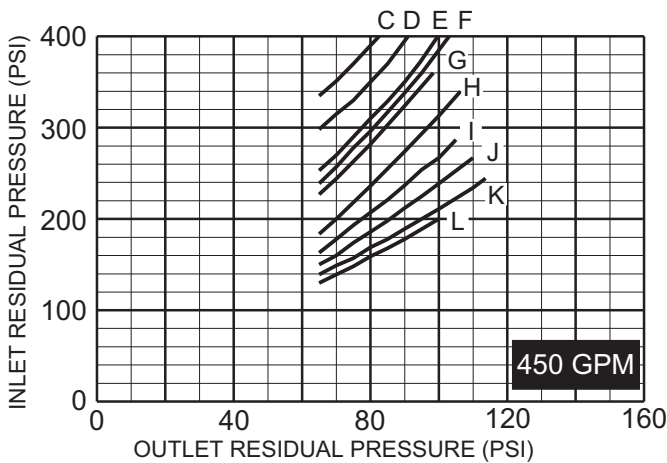
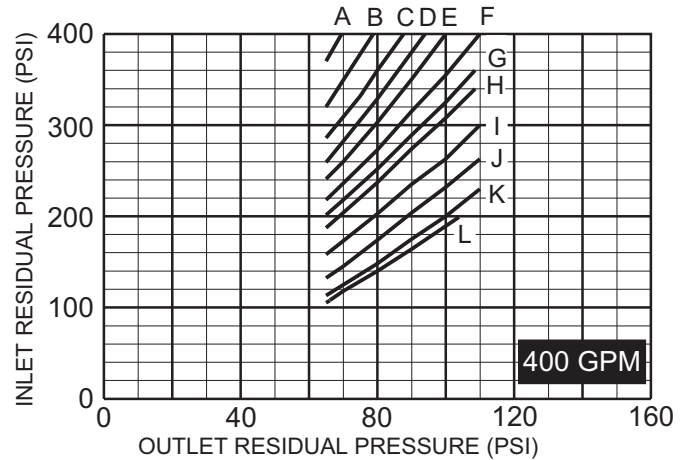
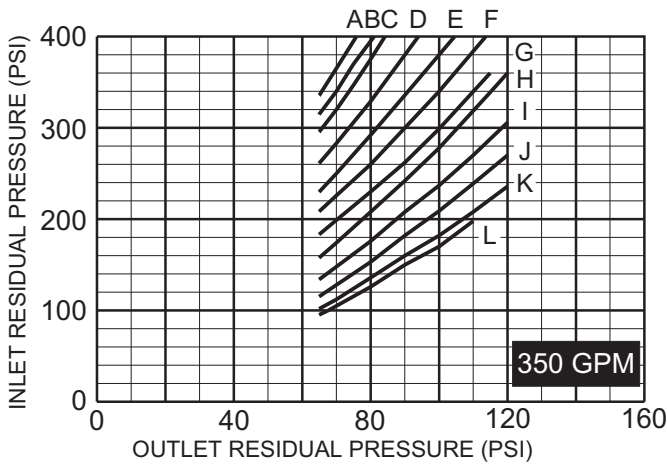

STATIC PRESSURE CHART

For Pressure-Tru™
Angle and In-line Valves
(2-1/2" Inlet and Outlet)

MODELS:
Z3000, Z3004 & Z3005
(All)

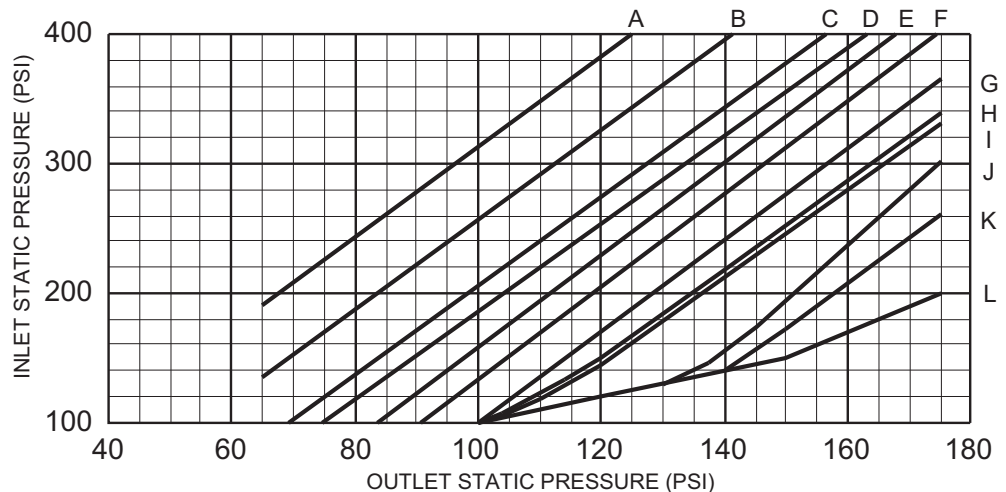

"A" DIMENSION SETTINGS (inches)

A	B	C	D	E	F	G	H	I	J	K	L
3/8	1/2	5/8	11/16	3/4	13/16	7/8	15/16	1	1-1/16	1-1/8	1-3/16

Note: Curve accuracy= ± 5 PSIG

Residual Pressure Charts

For Pressure-Tru™ 2 1/2" In-line Grooved Valves
 Models: Z3000ILG & Z3004ILG

Z3000 SERIES INLINE BODY GROOVED
50GPM

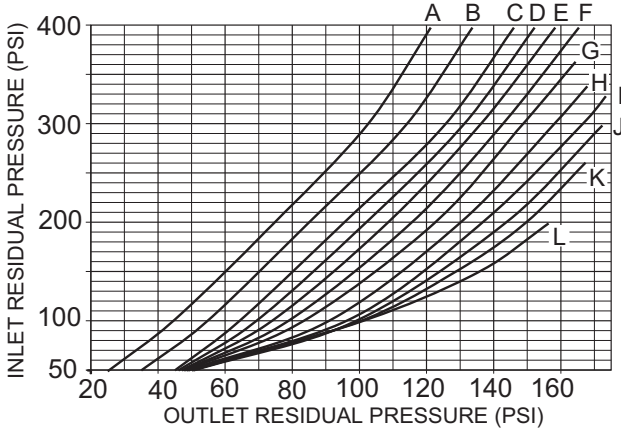

Z3000 SERIES INLINE BODY GROOVED
100GPM

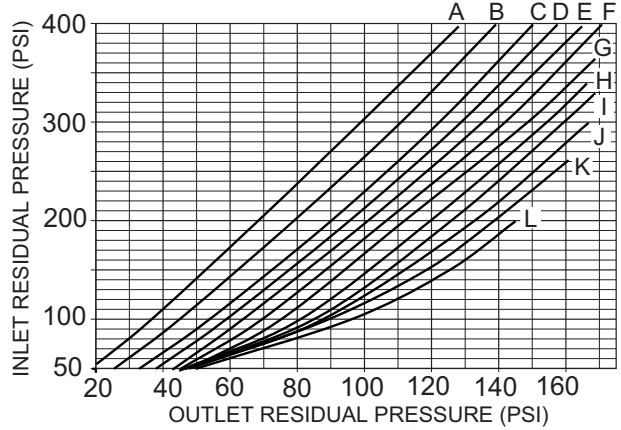

Z3000 SERIES INLINE BODY GROOVED
150GPM

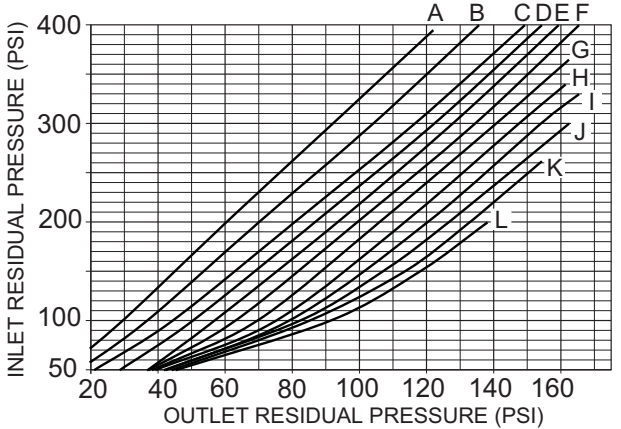

Z3000 SERIES INLINE BODY GROOVED
200GPM

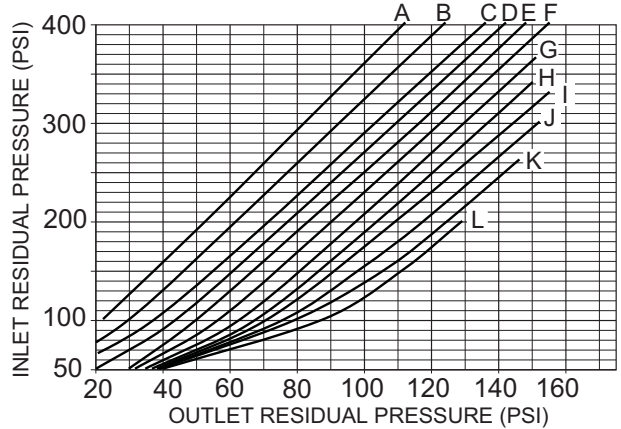

Z3000 SERIES INLINE BODY GROOVED
250GPM

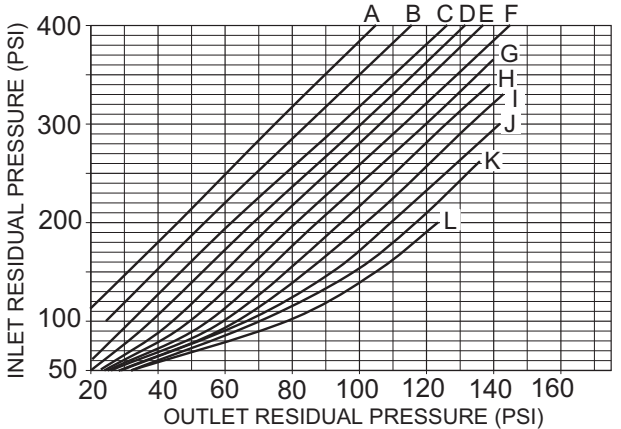

Z3000 SERIES INLINE BODY GROOVED
300GPM

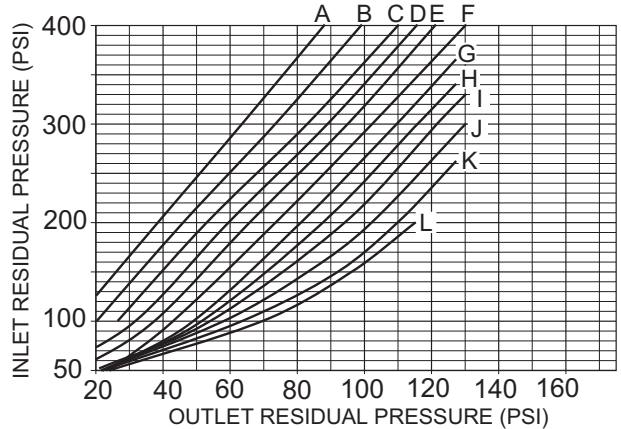

"A" DIMENSION SETTINGS (inches)

A	B	C	D	E	F	G	H	I	J	K	L
3/8	1/2	5/8	11/16	3/4	13/16	7/8	15/16	1	1-1/16	1-1/8	1-3/16

Note: Curve accuracy= ± 5 PSIG

Residual Pressure Charts

For Pressure-Tru™ 2 1/2" In-line Grooved Valves

Models: Z3000ILG & Z3004ILG

Z3000 SERIES INLINE BODY GROOVED

350GPM

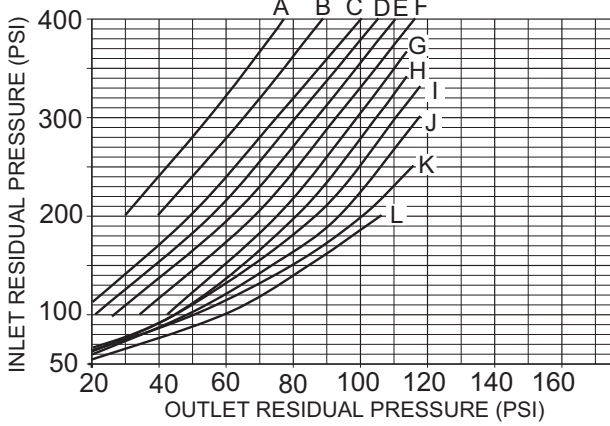

Z3000 SERIES INLINE BODY GROOVED

400GPM

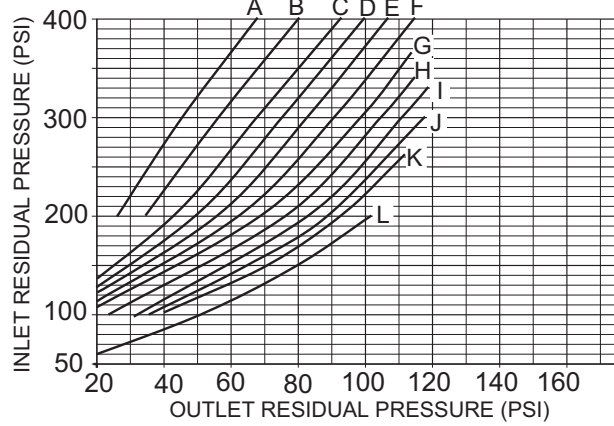

Z3000 SERIES INLINE BODY GROOVED

450GPM

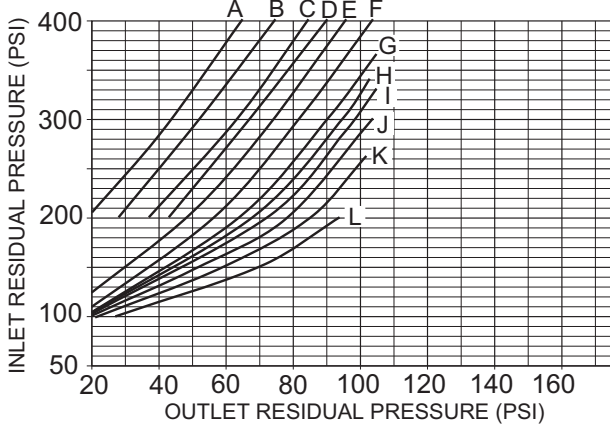

Z3000 SERIES INLINE BODY GROOVED

500GPM

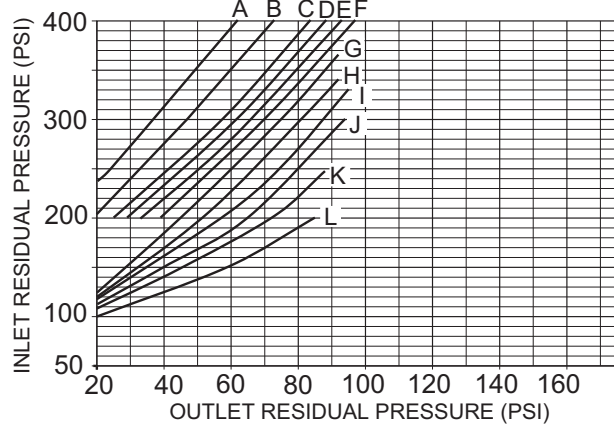

STATIC PRESSURE CHART

For Pressure-Tru™
Angle and In-line Valves
(2-1/2" Inlet and Outlet)

MODELS:
Z3000, Z3004 & Z3005
(All)

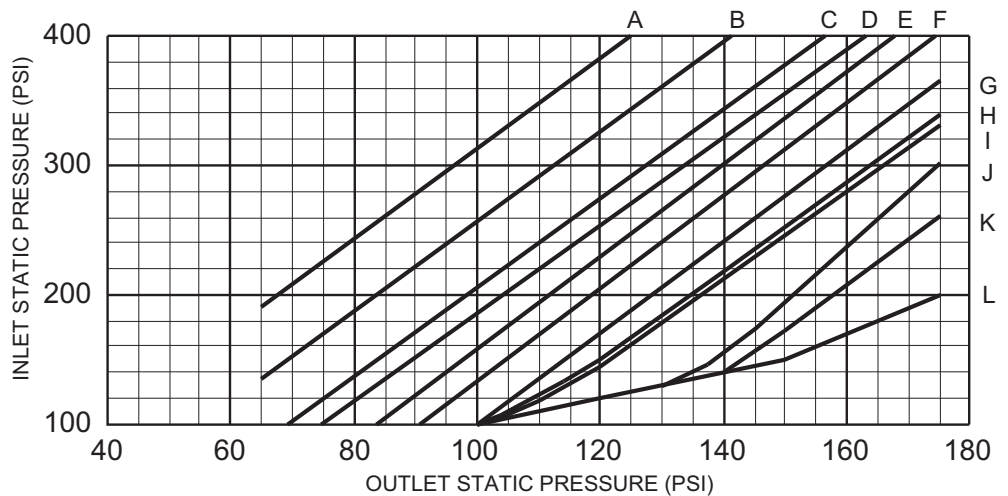

"A" DIMENSION SETTINGS (inches)

A	B	C	D	E	F	G	H	I	J	K	L
3/8	1/2	5/8	11/16	3/4	13/16	7/8	15/16	1	1-1/16	1-1/8	1-3/16

Note: Curve accuracy= ± 5 PSIG

ZW3000 Series Fire Valve Part Number Assistant



Check off the boxes that match the choices you want. If the choice is blank, this is standard and you add nothing to the part number. If there are letters after the check box, then you add those letters to the part number in that order from left to right.

The flow curves **Must** be used by the system designer to select the correct bonnet setting.

Example
2-1/2" Z3004 Sprinkler Floor Control Valve (Adjustable)

<input type="checkbox"/> Angle Body	<input type="checkbox"/> Threaded Ends	<input checked="" type="checkbox"/> SS Supervisory Switch	
<input type="checkbox"/> Globe Body	<input type="checkbox"/> Grooved Ends	Monitor Switch No Handwheel	
<input checked="" type="checkbox"/> IL	<input checked="" type="checkbox"/> G	Adapter Bracket Capped Bonnet	
(choose one)	(choose one)	<input type="checkbox"/> MSA <input type="checkbox"/> CAP	<input type="checkbox"/> CH
		(choose one or none)	(optional)

Rough Chrome Plated

In this example the part number would be ZW4004ILMSA-T

2-1/2" Z3000 Standpipe Hose Valve (Adjustable)

<input type="checkbox"/> Angle Body	<input type="checkbox"/> Threaded Inlet	<input type="checkbox"/> 2-1/2" National Hose thread	
<input type="checkbox"/> Globe Body	<input type="checkbox"/> Grooved Inlet	<input type="checkbox"/> 3" Hose thread	
<input type="checkbox"/> IL	<input type="checkbox"/> G	Special Thread	
(choose one)	(choose one)	<input type="checkbox"/> SF	<input type="checkbox"/> CC
		Specify special thread	w/Cap & Chain (optional)
		<input type="checkbox"/> ST _____	<input type="checkbox"/> CH
		(choose one)	(optional)

Rough Chrome Plated

2-1/2" Z3005 Hose Rack Valve (Adjustable)

<input type="checkbox"/> Angle Body		
<input type="checkbox"/> Globe Body	<input type="checkbox"/> NPT Threaded Outlet	
<input type="checkbox"/> IL	<input type="checkbox"/>	
(choose one)		<input type="checkbox"/> CH
		(optional)

Rough Chrome Plated

2-1/2" Z3004 Sprinkler Floor Control Valve (Adjustable)

<input type="checkbox"/> Angle Body	<input type="checkbox"/> Threaded Ends	<input type="checkbox"/> SS Supervisory Switch	
<input type="checkbox"/> Globe Body	<input type="checkbox"/> Grooved Ends	Monitor Switch No Handwheel	
<input type="checkbox"/> IL	<input type="checkbox"/> G	Adapter Bracket Capped Bonnet	
(choose one)	(choose one)	<input type="checkbox"/> MSA <input type="checkbox"/> CAP	<input type="checkbox"/> CH
		(choose one or none)	(optional)

Rough Chrome Chrome Plated

Specify if the body should be tapped and plugged for gauges.

Qty	Part number	Notes