



NATIONAL FIRE EQUIPMENT LTD.

SERVICE, SOLUTIONS, INNOVATION

RELY FX™ Stainless-Steel Fire Extinguisher Bracket

The RELY FX™ 81-682 Stainless Steel Fire Extinguisher bracket is specifically designed for durability and extended service life in harsh industrial, marine, and mining applications. This heavy-duty bracket has been evaluated to meet or exceed applicable NFPA, UL, ULC, and USCG standards, as well as military non-magnetic, vibration, and shock exposure requirements up to 200 Gs.

Accommodates all RELY FX 20-pound and 2.5-gallon fire extinguisher models.

Construction and Finish:

Corrosion-resistant 316 stainless steel construction with welded bracket back and bottom brace supports and liquid drainage corners. External bracket surface finished with a baked-on red epoxy powder paint to meet 1,000-hour salt spray USCG and Military shipboard requirements. Pre-drilled mounting holes match most common existing bracket hole patterns and accommodate mounting extinguishers in horizontal, vertical, or angled positions.

Release Arm with Locking Retention Pin and Chain:

Designed to permit the easy release and removal of fire extinguishers with less than 15 pounds (6.8 kg) of applied force after removing the pull pin. Large loop stainless-steel locking pull pin with extra thick shaft accommodates extinguisher removal while wearing gloves. An 8-inch (20.3cm) pull pin retention chain prevents loss of pull pin after removal. Stainless steel locking pull pin and retention arm release pull-point are contrasting colors for easy identification in low-light conditions. Retention arm features adjustable threaded stainless-steel hardware to properly secure extinguishers of varying diameters.

Replaceable Rubber Support Bumpers:

Bracket features twelve special durometer rubber support bumpers designed to securely hold and protect extinguisher in the bracket. Bumpers secured to bracket with threaded stainless-steel fasteners to accommodate simple replacements in the field and to maintain corrosion resistance.



| Rely FX Model 81-682 Stainless Steel Bracket | |
|---|--|
| Height: | 16.8 inches (42.7 cm) |
| Width: | 9.4 inches (23.9 cm) |
| Depth: | 8.1 inches (20.6 cm) |
| Weight: | 9.2 pounds (4.2 kg) |
| Mounting Holes: | 7/16 in (1.1 cm) |
| Military Non-Magnetic: | Mil-E-24091C (<i>pending</i>) |
| US Navy Specification: | Mil-DTL-24652A (SH) (<i>pending</i>) |
| Advanced Vibration Tested: | US Navy Mil-167-1 (<i>pending</i>) |
| Advanced Shock Tested: | US Navy MIL-901E (<i>pending</i>) |

All information listed herein is subject to change.

PS26111-A

RELY FX™ Heavy-Duty Stainless-Steel Bracket Dimensions

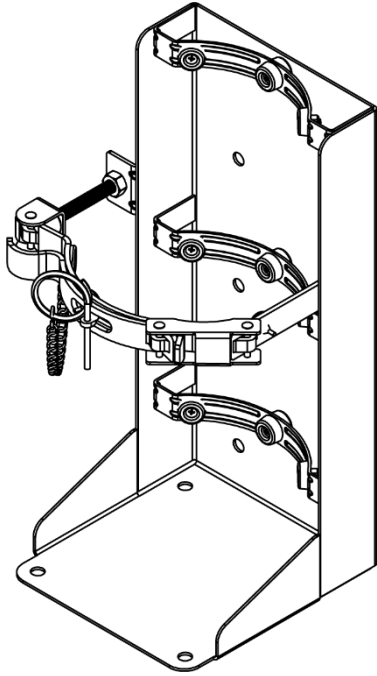

**Vertical Installation
(Preferred Method)**

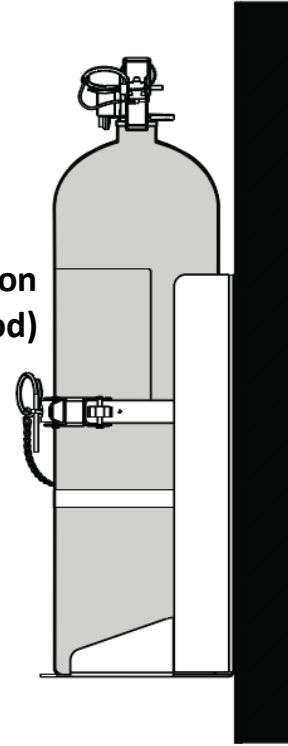

Bracket Back View

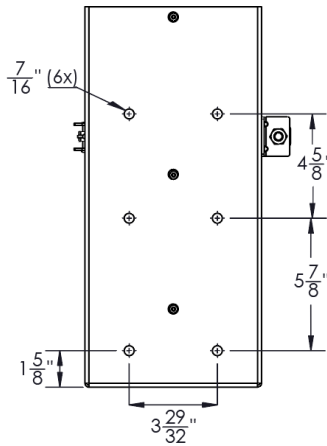

Bracket Side View

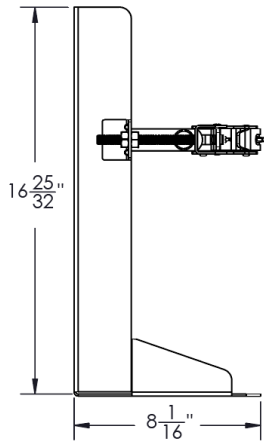

Angled Installation

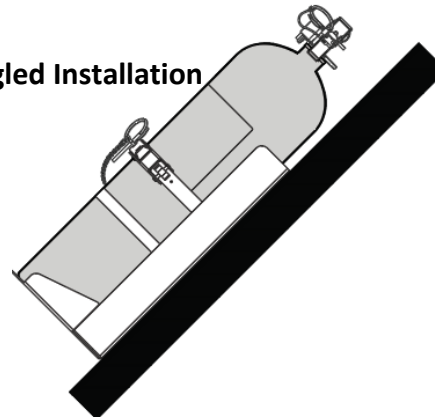

Bracket Top View

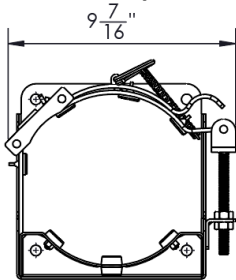

Bracket Bottom View

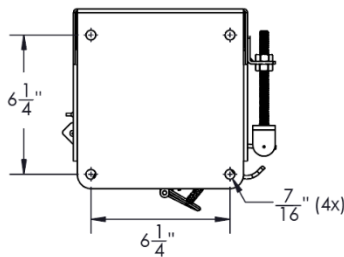

Horizontal Installation

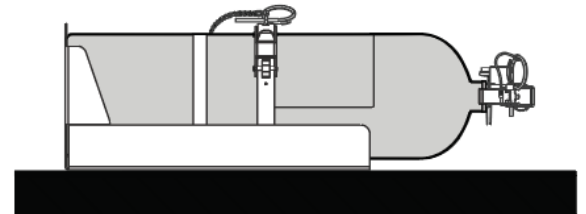

PS26111-A