



RELY FX™ Heavy-Duty Black Steel Fire Extinguisher Bracket

The RELY FX™ 81-681 Black Steel fire extinguisher bracket is specifically designed for durability and extended service life in harsh industrial, marine, and mining applications. This heavy-duty bracket has been evaluated to meet or exceed applicable NFPA, UL, ULC, and USCG standards.

Accommodates all RELY FX 20-pound and 2.5-gallon fire extinguisher models.

Construction and Finish:

Heavy-duty steel construction with welded bracket back and bottom brace supports and liquid drainage corners. External bracket surface finished with a corrosion-resistant baked-on black powder paint. Pre-drilled mounting holes match most common existing bracket hole patterns and accommodate mounting extinguishers in horizontal, vertical, or angled positions.

Release Arm with Locking Retention Pin and Chain:

Designed to permit the easy release and removal of fire extinguishers with less than 15 pounds (6.8 kg) of applied force after removing the pull pin. Large loop stainless-steel locking pull pin with extra thick shaft accommodates extinguisher removal while wearing gloves. An 8-inch (20.3cm) pull pin retention chain prevents loss of pull pin after removal. Stainless steel locking pull pin and retention arm release pull-point are contrasting colors for easy identification in low-light conditions. Retention arm features adjustable threaded stainless-steel hardware to properly secure extinguishers of varying diameters.

Replaceable Rubber Support Bumpers:

Bracket features twelve special durometer rubber support bumpers designed to securely hold and protect extinguisher throughout the life cycle of bracket. Bumpers secured to bracket with threaded stainless-steel fasteners to accommodate simple replacements in the field and to maintain corrosion resistance.



Rely FX Model 81-681 Stainless Steel Bracket	
Height:	16.8 inches (42.7 cm)
Width:	9.4 inches (23.9 cm)
Depth:	8.1 inches (20.6 cm)
Weight:	8.7 pounds (3.9 kg)
Mounting Holes:	7/16 in (1.1 cm)

All information listed herein is subject to change.

PS26112-A

RELY FX™ Heavy-Duty Black Steel Fire Extinguisher Bracket Dimensions

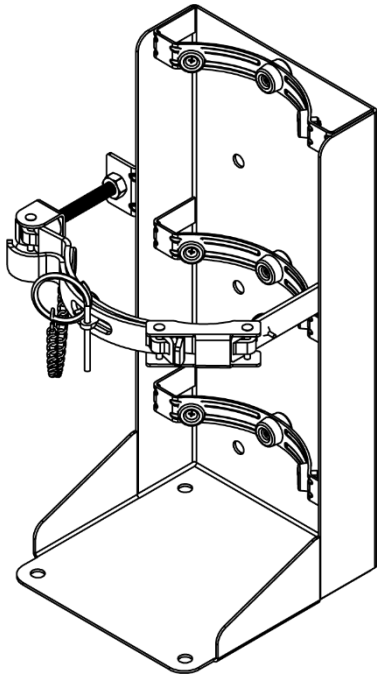

**Vertical Installation
(Preferred Method)**

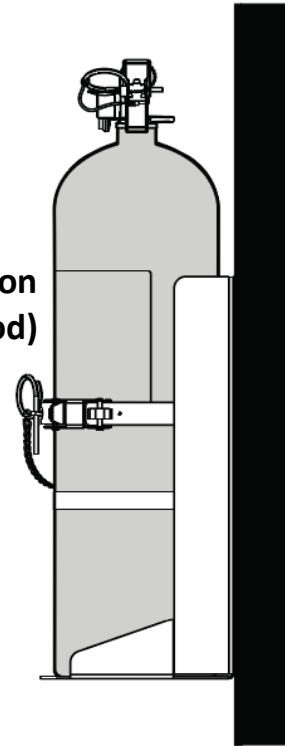

Bracket Back View

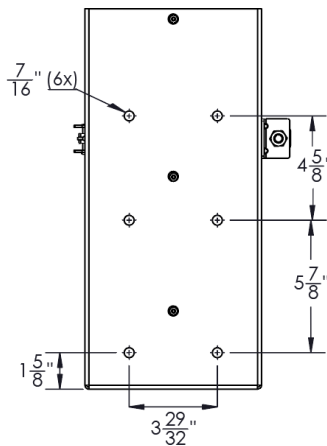

Bracket Side View

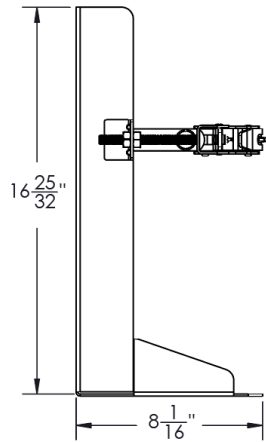

Angled Installation

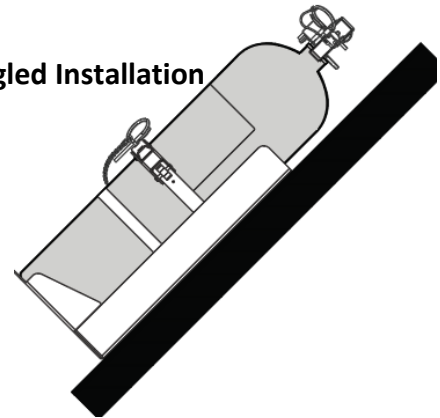

Bracket Top View

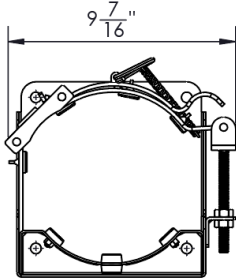

Bracket Bottom View

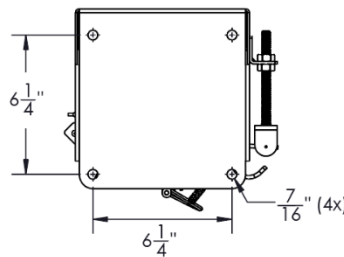

Horizontal Installation

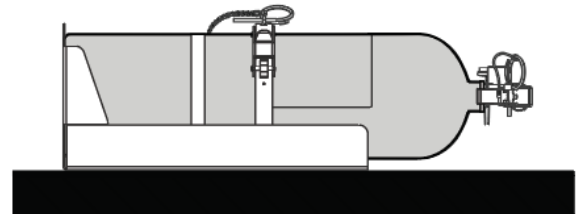

PS26112-A